

# COÏA CARRIER BOUCLÉ

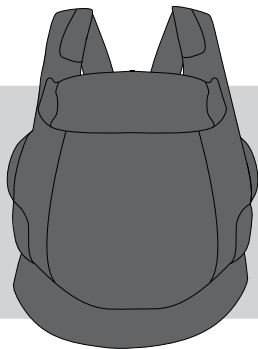

cybex *Club*

Register here  
and unlock  
your benefits

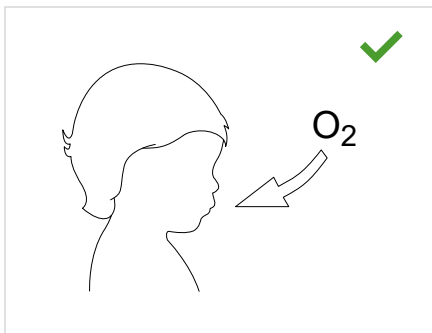
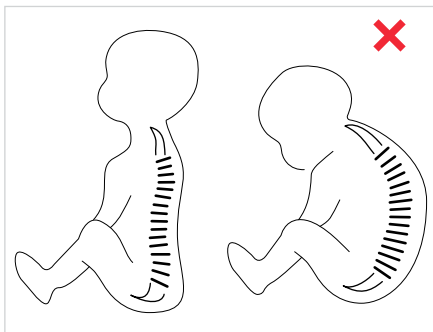

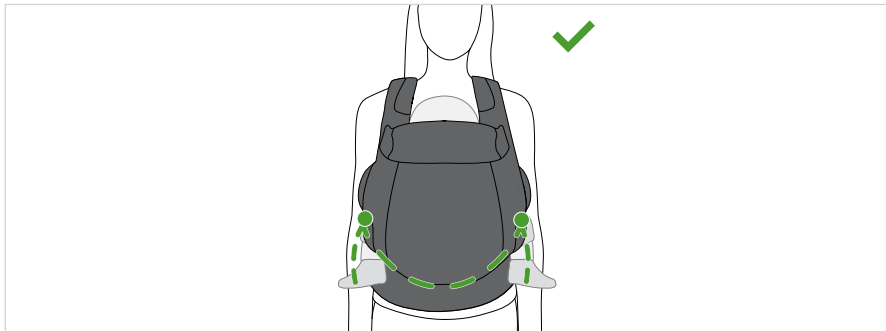

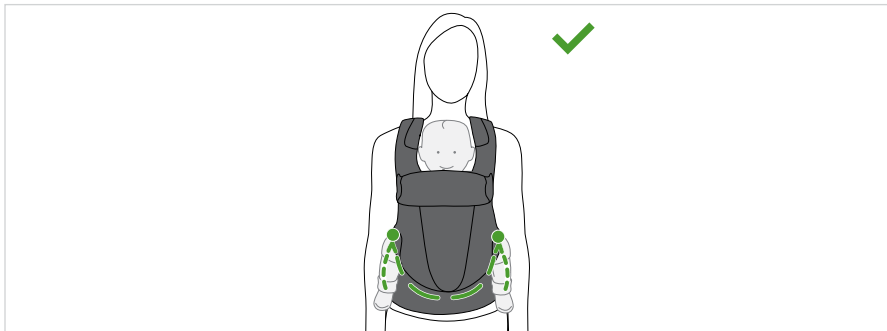



0 - 6 Mo.

Min. 3,2 kg (7 lb)



6 - 36 Mo.

Max. 15 kg (33 lb)



**EN** WARNING  
**DE** WARNUNG  
**ES** ADVERTENCIA  
**FR** AVERTISSEMENT  
**PT** AVISOS  
**IT** ATTENZIONE  
**NL** WAARSCHUWING  
**PL** OSTRZEŻENIE  
**CZ** UPOZORNĚNÍ  
**SK** UPOZORNENIE  
**SL** OPOZORILO  
**HR** UPOZORENJE  
**HU** FIGYELMEZTETÉS  
**SE** VARNING  
**NO** ADVARSEL  
**FI** VAROITUS  
**DA** ADVARSEL  
**ET** HOIATUS  
**LV** BRĪDINĀJUMS  
**LT** PERSPĖJIMAS  
**RU** ВНИМАНИЕ  
**UK** УВАГА  
**TR** UYARI  
**EL** ΠΡΟΕΙΔΟΠΟΙΗΣΗ  
**RO** AVERTISMENTE  
**IS** VIÐVÖRUN  
**MT** TWISSIJA

**AR**  
**FA**  
**YUE** 警告  
**CMN** 警告  
**JA** 警告  
**KO** 경고  
**BG** ПРЕДУПРЕЖДЕНИЕ  
**SR** UPOZORENJE  
**MS** AMARAN  
**HI** चेतावनी  
**TH** คำเตือน  
**SQ** PARALAJMËRIM  
**BS** UPOZORENJE  
**ME** UPOZORENJE  
**MK** ПРЕДУПРЕДУВАЊЕ  
**HY** շՊԻՇԱՑՈՒՄ  
**VI** CẢNH BÁO

تحذير  
اخطار



**EN** Tutorial video  
**DE** Videoanleitung  
**ES** Tutorial en video  
**FR** Vidéo de démonstration  
**PT** Video tutorial  
**IT** Video tutorial  
**NL** Instructievideo  
**PL** Film instruktażowy  
**CZ** Výukové video  
**SK** Výukové video  
**SL** Video z navodili  
**HR** Video s uputama  
**HU** Bemutatóvideó  
**SE** Videosjälvstudiekurs  
**NO** Oppføringsvideo  
**FI** Opetusvideo  
**DA** Vejledende video  
**ET** Õppevideo  
**LV** Ar mācību video  
**LT** Mokomasis vaizdo įrašas  
**RU** Обучающее видео  
**UK** Навчальне відео  
**TR** Öğretici video  
**EL** Εκπαιδευτικό βίντεο  
**RO** Video tutorial  
**IS** Kennslumyndband  
**MT** Tutorial fuq vidjow



**AR**  
**FA**  
**YUE** 教程視頻  
**CMN** 教程视频  
**JA** チュートリアルビデオ  
**KO** 튜토리얼 동영상  
**BG** Учебно видео  
**SR** Video sa uputstvima  
**MS** Video tutorial  
**HI** ट्यूटोरियल वीडियो  
**TH** วีดีโอแนะนำ  
**SQ** Video udhëzuese  
**BS** Video sa uputstvima  
**ME** Video sa uputstvima  
**MK** Видеоупатство  
**HY** Παιδαγωγικά βίντεο  
**VI** Video hướng dẫn

فيديو تعليمي  
ويدئوى آموزشى

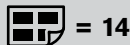

استخدام حلقة الساق  
استفاده از حلقه پا

- EN** Using the Legloop  
**DE** Verwendung der Beinschlaufe  
**ES** Uso del lazo de la pierna  
**FR** Utilisation de la boucle de jambe  
**PT** Uso do laço da perna  
**IT** Utilizzo della cinghia per la gamba  
**NL** Gebruik van de beenlus  
**PL** Użycie pętli na nogę  
**CZ** Použití nohavice smyčka  
**SK** Použitie nohavice slučka  
**SL** Uporaba nogo zanke  
**HR** Korištenje petlje za nogu  
**HU** A láb hurok használata  
**SE** Användning av benöglå  
**NO** Bruk av benløkken  
**FI** Jalkalenkin käyttö  
**DA** Brug af benløkke  
**ET** Jala silmuse kasutamine  
**LV** Izmantojot kāju cilpu  
**LT** Naudodami kojų petį  
**RU** Использование ножной петли  
**UK** Використання нога петлі  
**TR** Bacak halkası kullanarak  
**EL** Χρησιμοποιώντας την πατούσα περιλούπα  
**RO** Utilizând bucla pentru picior  
**IS** Með að nota fótahringinn  
**MT** B'uzu tal-irkoppa

- AR**  
**FA**  
**YUE** 使用腳環  
**CMN** 使用腿環  
**JA** 足ループの使用  
**KO** 다리 루프 사용  
**BG** Използване на краката петли  
**SR** Koristeći petlju za nogu  
**MS** Menggunakan gelang kaki  
**HI** पैर का उपयोग  
**TH** การใช้วงแขน  
**SQ** Përdorimi i gajtës së këmbës  
**BS** Koristeći petlju za nogu  
**ME** Koristeći petlju za nogu  
**MK** Користење на јамката за нога  
**HY** Գրպետի որակի ուշադրությունը  
**VI** Sử dụng vòng chân

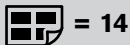

**EN** Using the Waist belt  
**DE** Verwendung des Taillengurts  
**ES** Uso del cinturón  
**FR** Utilisation de la ceinture  
**PT** Utilização do cinto abdominal  
**IT** Utilizzo della cintura addominale  
**NL** De taillegordel gebruiken  
**PL** Korzystanie z pasa taliowego  
**CZ** Použití brňišního pásu  
**SK** Používanie opasku  
**SL** Uporaba pasu za okrog pasu  
**HR** Korištenje pojasa za krilo  
**HU** A deréköv használata  
**SE** Använda midjebandet  
**NO** Bruke midjebeltet  
**FI** Lantiovyön käyttäminen  
**DA** Brug af bælte  
**ET** Võõrihma kasutamine  
**LV** Vidukļa jostas izmantošana  
**LT** Juosmens diržo naudojimas  
**RU** Использование поясного ремня  
**UK** Використання поясного ремня  
**TR** Bel kemerinin kullanımı  
**EL** Χρήση της ζώνης μέσης  
**RO** Utilizarea centurii pentru talie  
**IS** Að nota mittisbeltið  
**MT** Kif tuża ċ-ċinturin tal-qadd

**AR** استخدام حزام الخصر  
**FA** استفاده از کمربند  
**YUE** 使用腰帶  
**CMN** 使用腰带  
**JA** 腰ベルトの使い方  
**KO** 허리 벨트 사용  
**BG** Използване на колана за кръста  
**SR** Upotreba pojasa za krilo  
**MS** Menggunakan tali pinggang  
**HI** वेस्ट बेल्ट का उपयोग करना  
**TH** การใช้เข็มขัดคาดเอว  
**SQ** Përdorimi i rripit të mesit  
**BS** Korištenje pojasa za krilo  
**ME** Korišćenje pojasa za krilo  
**MK** Употреба на појасот за половина  
**HY** Գոտկաւստեղի ամրագոտու օգտագործումը  
**VI** Sử dụng đai thắt lưng

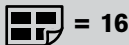

<b>EN</b>	Using the shoulder belt
<b>DE</b>	Verwendung des Schultergurts
<b>ES</b>	Uso del cinturón para los hombros
<b>FR</b>	Utilisation de la bretelle
<b>PT</b>	Utilização do cinto de ombro
<b>IT</b>	Utilizzo delle cinture
<b>NL</b>	De schoudergordel gebruiken
<b>PL</b>	Korzystanie z pasa barkowego
<b>CZ</b>	Použití ramenního pásu
<b>SK</b>	Používanie ramenného pásu
<b>SL</b>	Uporaba ramenskega pasu
<b>HR</b>	Korištenje pojasa za ramena
<b>HU</b>	A vállöv használata
<b>SE</b>	Använda axelbandet
<b>NO</b>	Bruke skulderbeltet
<b>FI</b>	Olkahihnan käyttäminen
<b>DA</b>	Brug af skulderrem
<b>ET</b>	Õlarihma kasutamine
<b>LV</b>	Plecu siksnu izmantošana
<b>LT</b>	Diržo per petį naudojimas
<b>RU</b>	Использование плечевого ремня
<b>UK</b>	Використання плечевого ремня
<b>TR</b>	Omuz kemerinin kullanımı
<b>EL</b>	Χρήση της ζώνης ώμου
<b>RO</b>	Utilizarea centurii pentru umeri
<b>IS</b>	Að nota axlarbeltið
<b>MT</b>	Kif tuża ċ-ċinturin tal-ispalla

<b>AR</b>	استخدام حزام الكتف
<b>FA</b>	استفاده از بند شانه
<b>YUE</b>	使用肩帶
<b>CMN</b>	使用肩帶
<b>JA</b>	肩ベルトの使い方
<b>KO</b>	어깨 벨트 사용
<b>BG</b>	Използване на колана през рамото
<b>SR</b>	Upotreba pojasa za ramena
<b>MS</b>	Menggunakan tali pinggang bahu
<b>HI</b>	शोल्डर बेल्ट का उपयोग करना
<b>TH</b>	การใช้เข็มขัดคาดไหล่
<b>SQ</b>	Përdorimi i rripit të supave
<b>BS</b>	Korištenje pojasa za ramena
<b>ME</b>	Korišćenje pojasa za ramena
<b>MK</b>	Употреба на појасот за рамо
<b>HY</b>	Ուսադոսող ամրագոտող օգտագործումը
<b>VI</b>	Sử dụng đai vai



**EN** Using the neck support  
**DE** Verwendung der Nackenstütze  
**ES** Uso del soporte para el cuello  
**FR** Utilisation de l'appui-nuque  
**PT** Utilização do suporte do pescoço  
**IT** Utilizzo del supporto per il collo  
**NL** De nekondersteuning gebruiken  
**PL** Korzystanie z podparcia szyi  
**CZ** Použití krční opěrky  
**SK** Používanie podpery krku  
**SL** Uporaba opore za vrat  
**HR** Korištenje potpore za vrat  
**HU** A nyaktámasz használata  
**SE** Använda nackstödet  
**NO** Bruke nakkestøtten  
**FI** Niskatuen käyttäminen  
**DA** Brug af nakkestøtte  
**ET** Kaelatoe kasutamine  
**LV** Kakla atbalsta izmantošana  
**LT** Kaklo atramos naudojimas  
**RU** Использование опоры для шеи  
**UK** Використання підтримки шиї  
**TR** Boyun desteğinin kullanımı  
**EL** Χρήση του στηρίγματος αυχένα  
**RO** Utilizarea suportului pentru ceafă  
**IS** Að nota hálsstuðninginn  
**MT** Kif tuża l-appoġġ għall-għonq

**AR** استخدام وسادة الرقبة  
**FA** استفاده از ساپورت گردن  
**YUE** 使用頸托  
**CMN** 使用颈托  
**JA** ネックサポートの使い方  
**KO** 목 받침대 사용  
**BG** Използване на опората за врата  
**SR** Upotreba naslona za vrat  
**MS** Menggunakan penyokong leher  
**HI** नेक सपोर्ट का उपयोग करना  
**TH** การใช้อุปกรณ์พยุงคอ  
**SQ** Përdorimi i mbajtëses së qafës  
**BS** Korištenje potpore za vrat  
**ME** Korišćenje naslona za vrat  
**MK** Употреба на потпирачот за вратот  
**HY** Վզի հենասարքի օգտագործումը  
**VI** Sử dụng tấm đỡ cổ



- EN** Using the storage bag  
**DE** Verwendung der Aufbewahrungstasche  
**ES** Uso de la bolsa de almacenamiento  
**FR** Utilisation du sac de rangement  
**PT** Utilização do saco de armazenamento  
**IT** Utilizzo della borsa custodia  
**NL** De opbergtas gebruiken  
**PL** Korzystanie z torby do przechowywania  
**CZ** Použití úložné tašky  
**SK** Používanie tašky na uskladnenie  
**SL** Uporaba torbe za shranjevanje  
**HR** Korištenje torbe za pohranu  
**HU** A tárolózsák használata  
**SE** Använda förvaringspåsen  
**NO** Bruke oppbevaringsposen  
**FI** Säilytyskassin käyttäminen  
**DA** Brug af opbevaringstasken  
**ET** Hoiukoti kasutamine  
**LV** Uzglabāšanas somas izmantošana  
**LT** Daiktų krepšio naudojimas  
**RU** Использование сумки для хранения  
**UK** Використання сумки для зберігання  
**TR** Saklama çantasının kullanımı  
**EL** Χρήση της τσάντας αποθήκευσης  
**RO** Utilizarea geții de depozitare  
**IS** Að nota geymslupokann  
**MT** Kif tuża l-borża tal-ħażna

- AR** استخدام حقيبة التخزين  
**FA** استفاده از کیف حمل و نگهداری  
**YUE** 使用儲物袋  
**CMN** 使用储物袋  
**JA** 保管バッグの使い方  
**KO** 보관 가방 사용  
**BG** Използване на чантата за съхранение  
**SR** Upotreba torbe za odlaganje  
**MS** Menggunakan beg penyimpanan  
**HI** स्टोरेज बैग का उपयोग करना  
**TH** การใช้ถุงเก็บของ  
**SQ** Përdorimi i çantës  
**BS** Korištenje torbe za odlaganje  
**ME** Korišćenje torbe za odlaganje  
**MK** Употреба на торбата за складирање  
**HY** Դիտպանման պարկի օգտագործումը  
**VI** Sử dụng túi đựng

استخدام حقيبة التخزين  
استفاده از کیف حمل و نگهداری



 = 22



 = 28



 = 29



 = 36



 = 38



 = 44



 = 46



 = 52



 = 54



 = 61

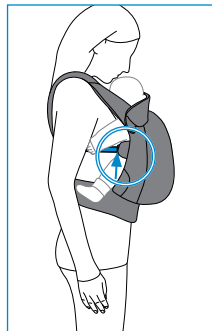

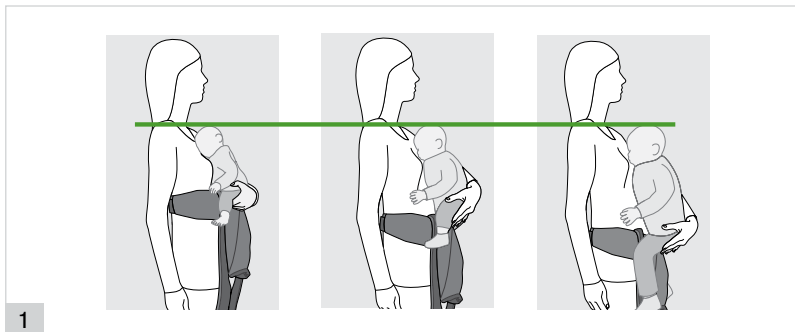
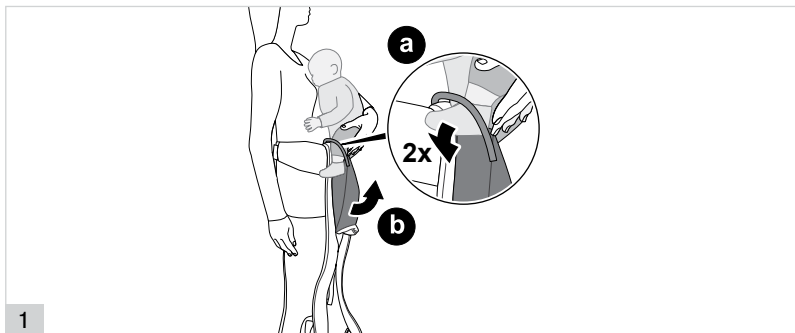

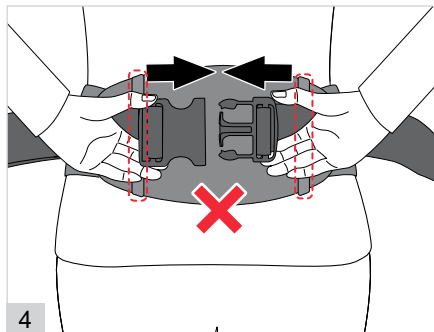
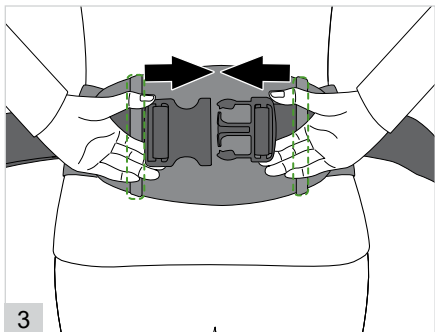
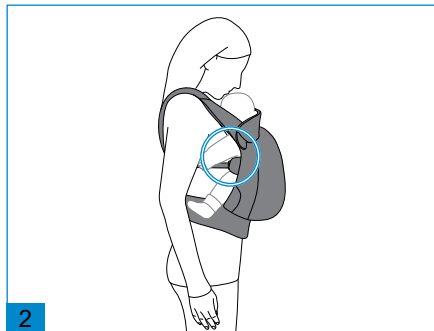
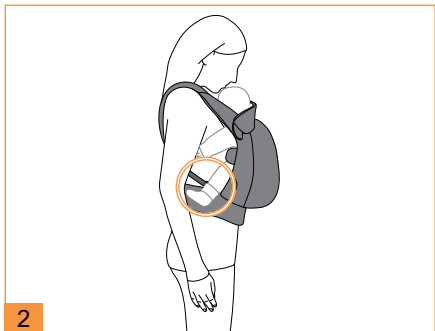

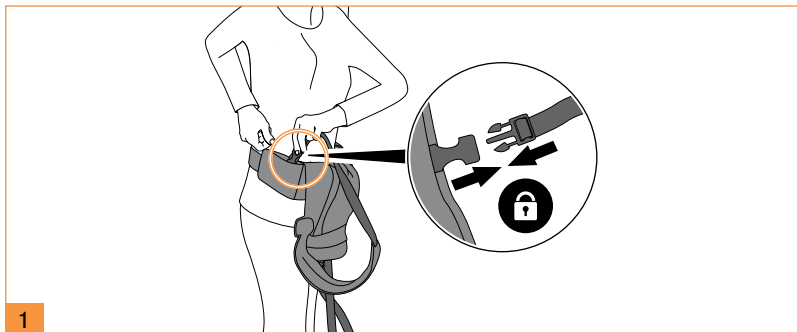
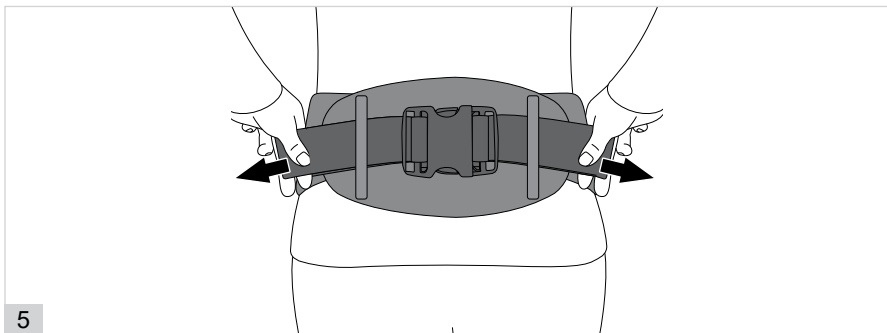

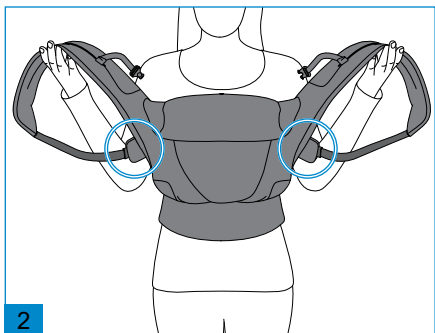
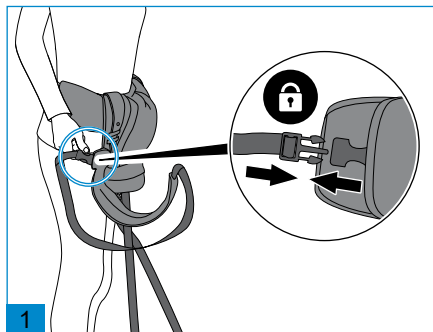
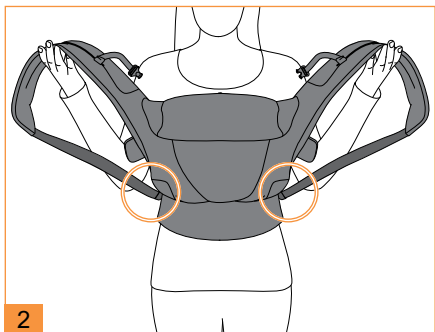



1

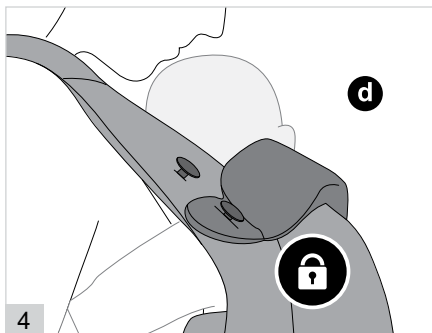
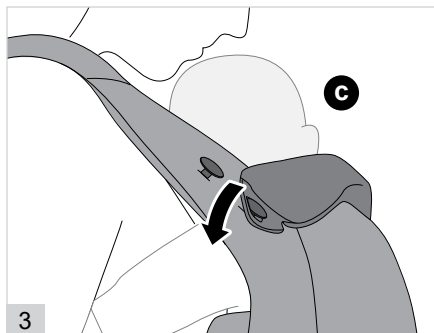
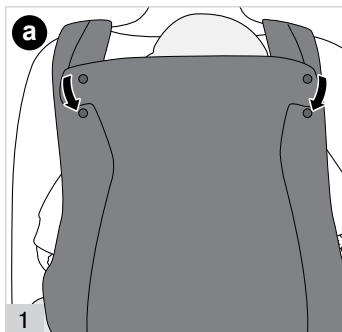

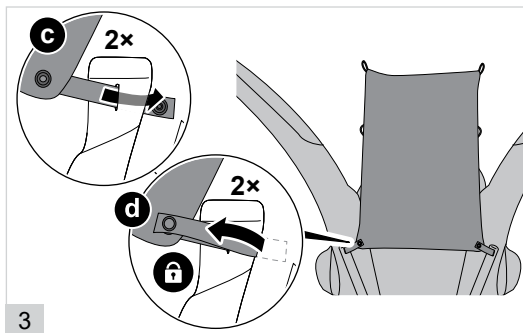
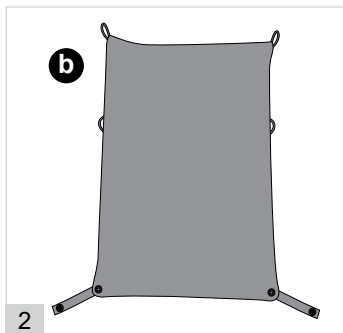
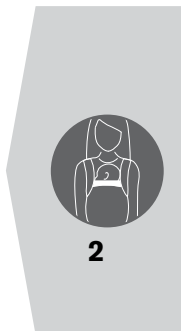
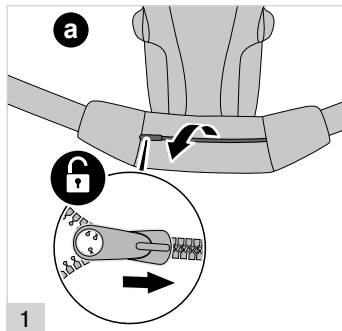
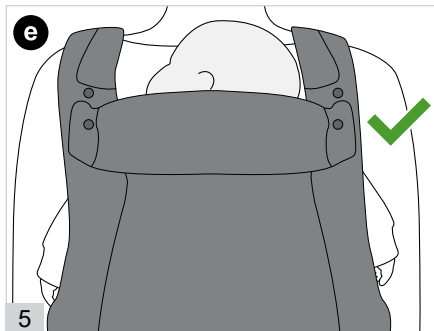

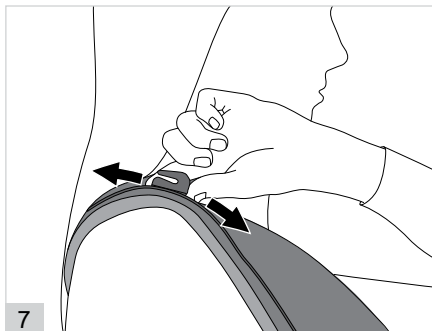
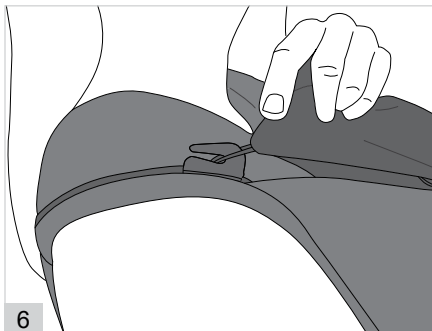
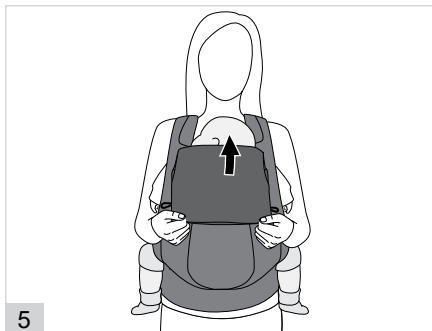
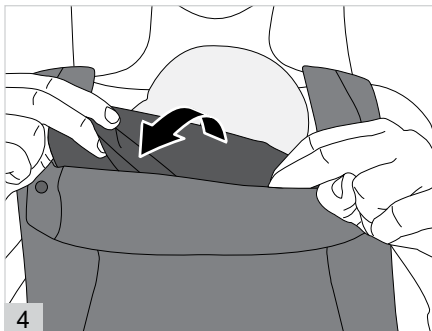

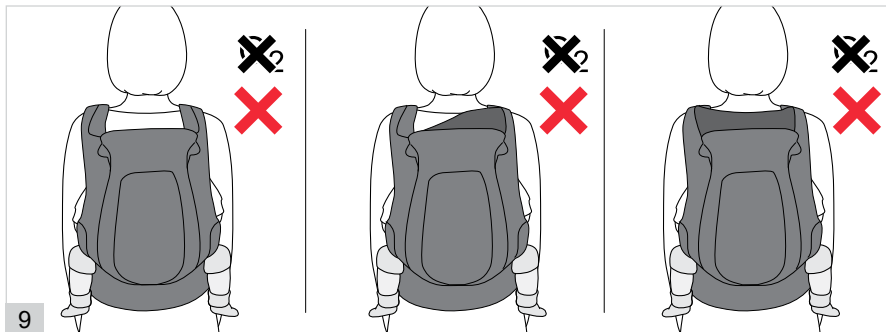
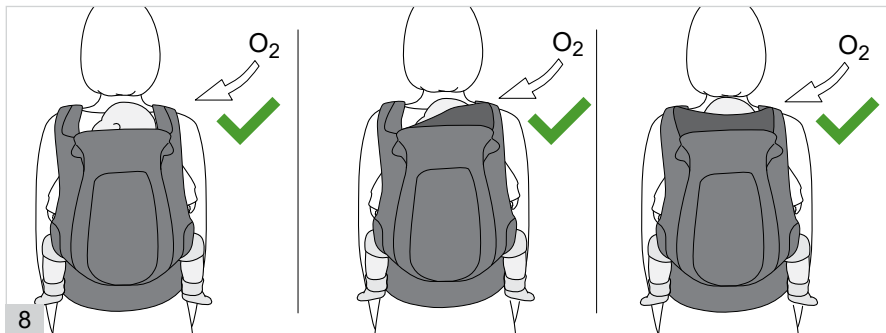

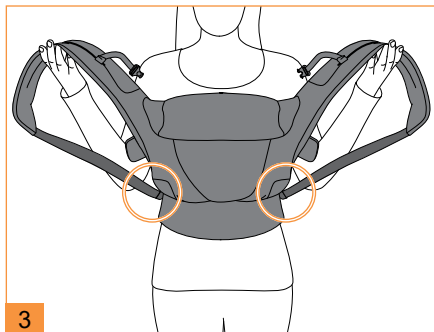
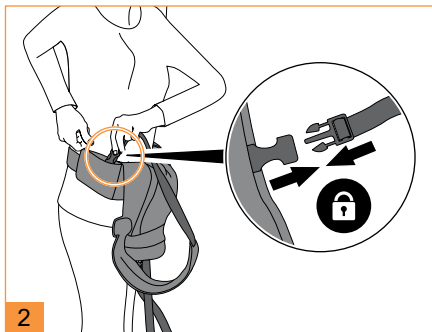
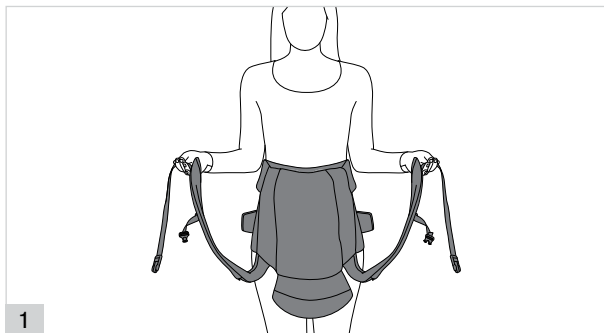

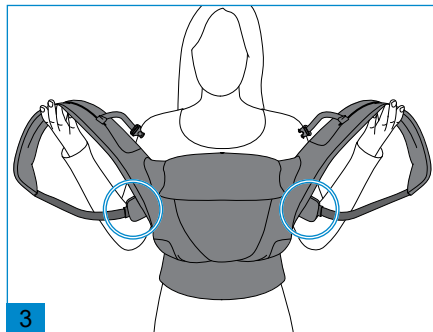
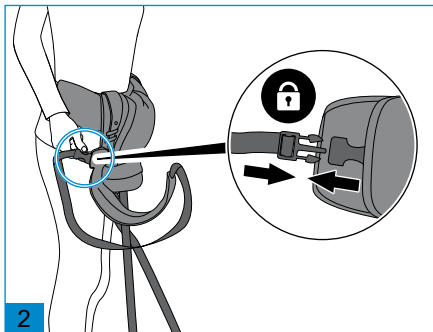

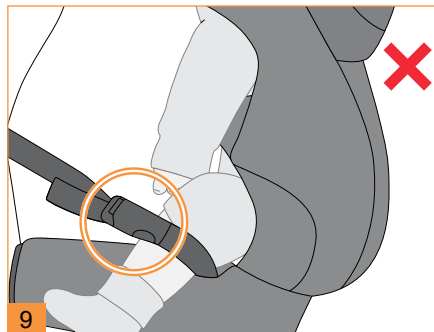
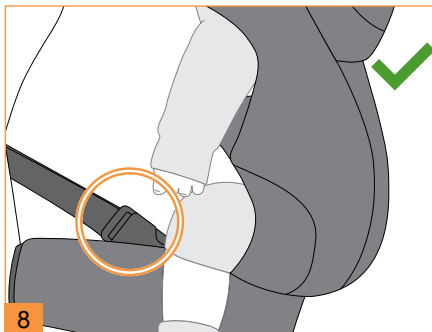
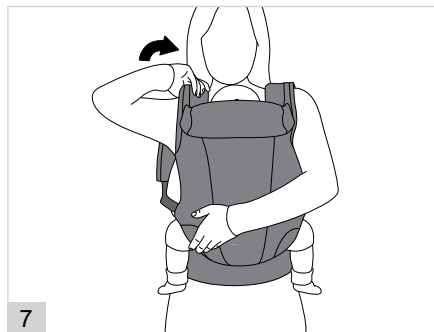

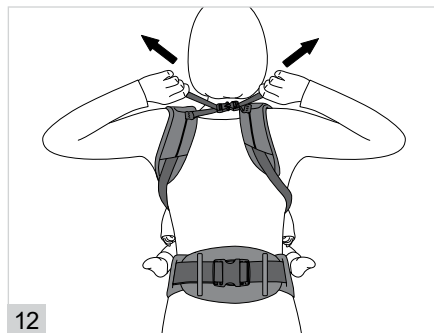
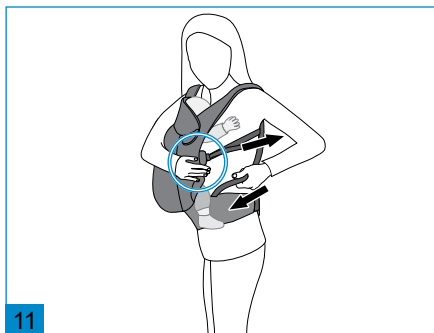
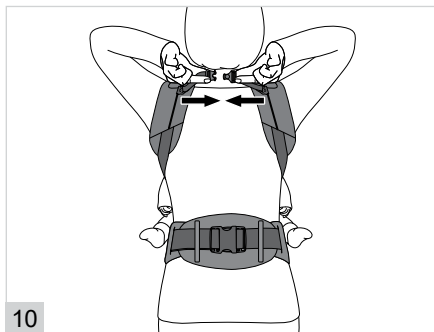

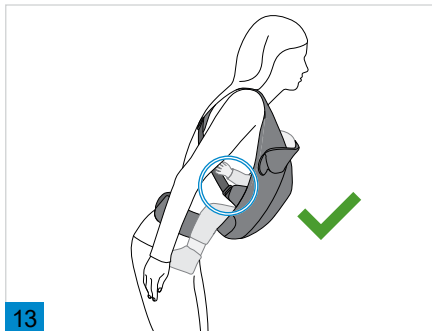
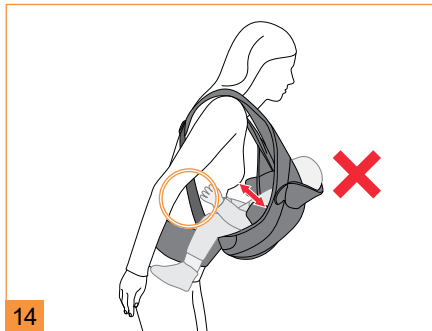
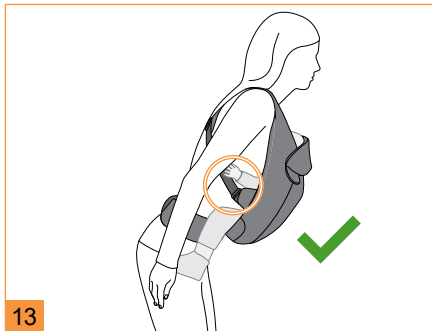

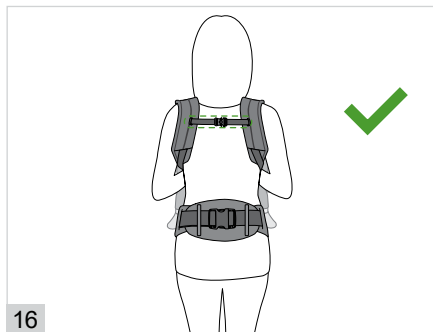

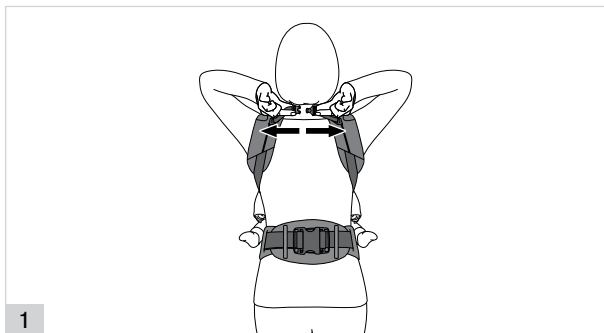

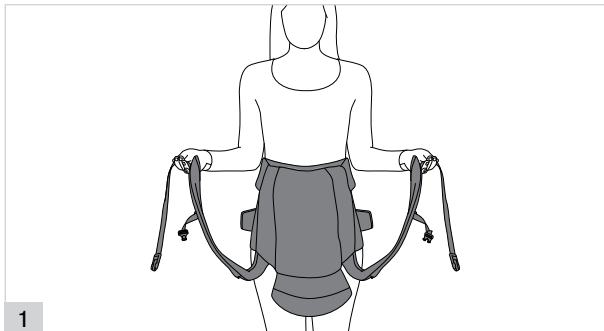
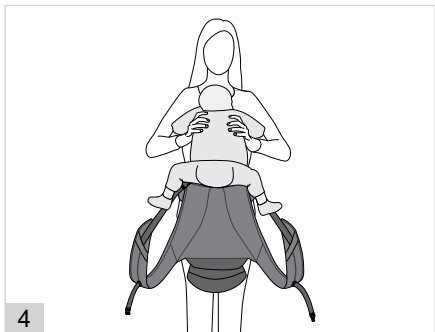

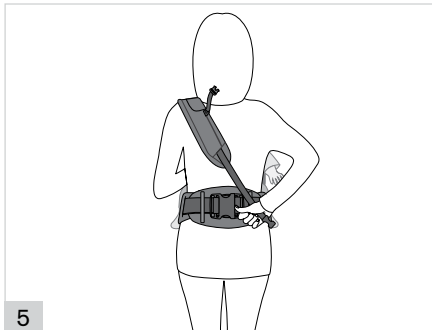

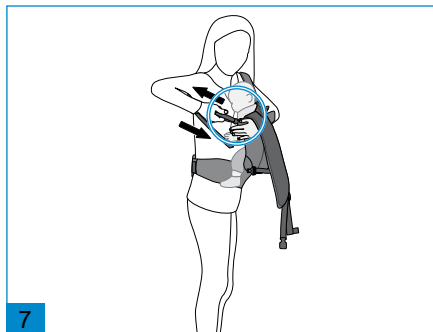
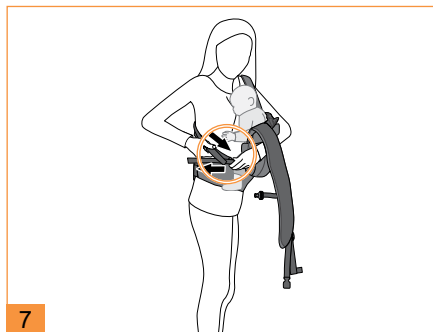
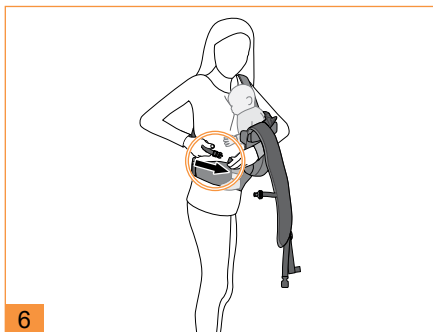

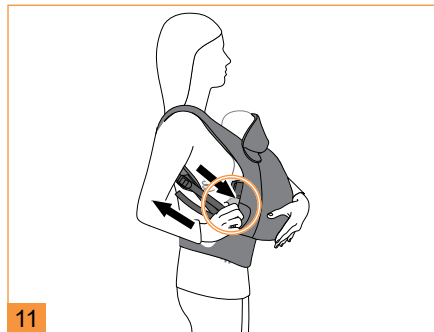
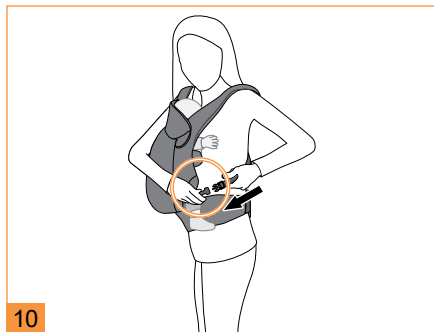
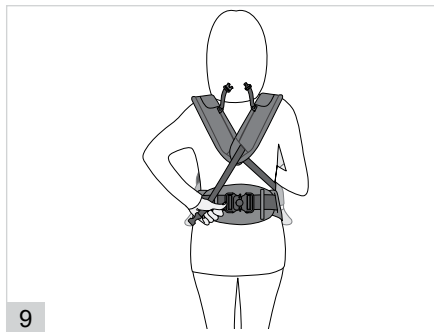
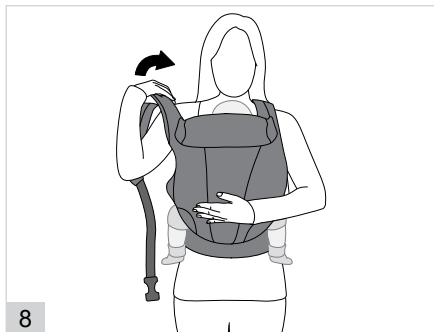

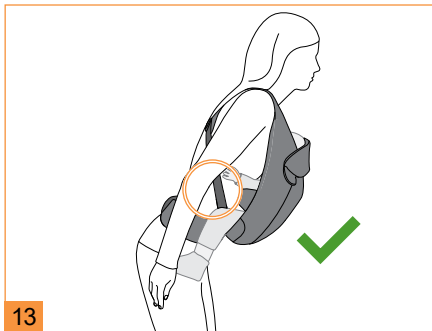
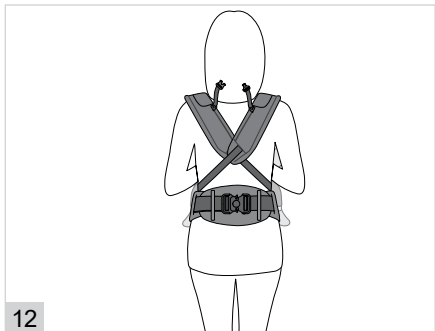
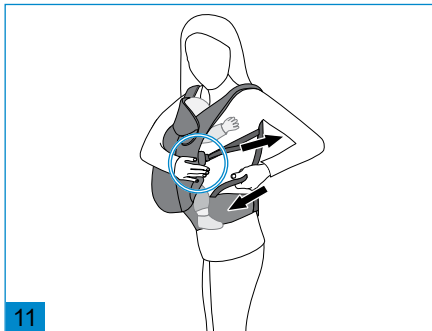
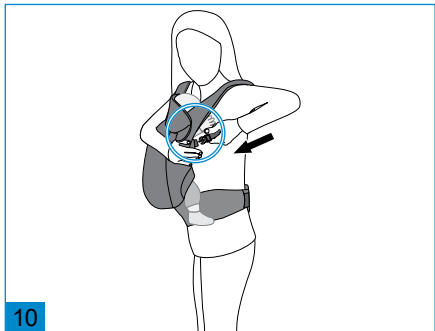

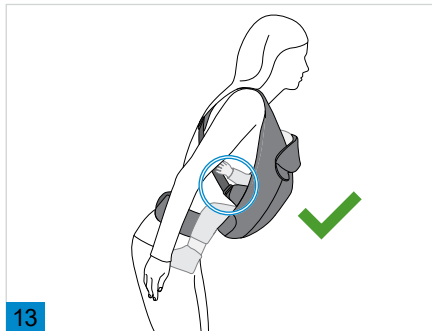

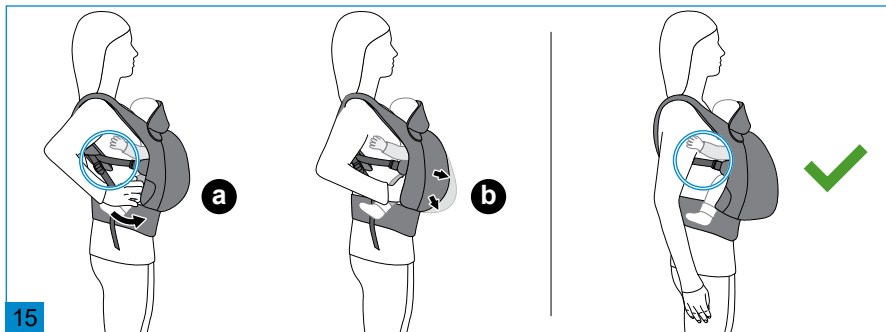
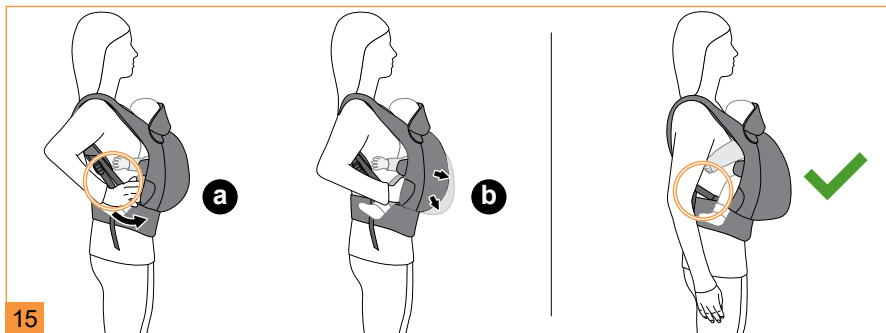

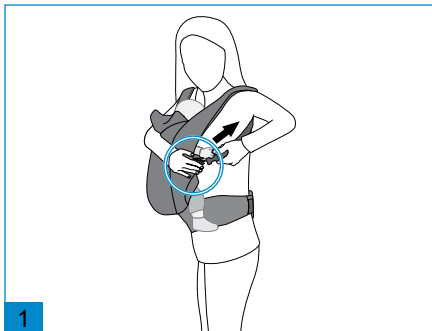

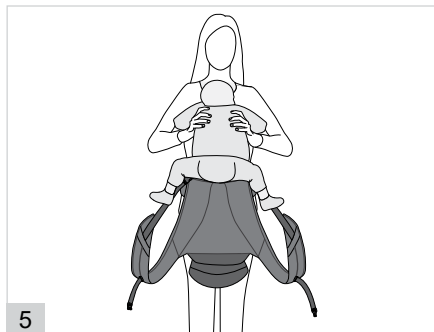
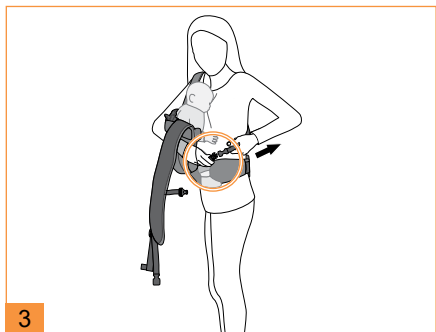

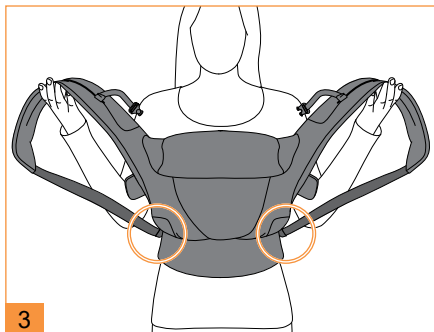
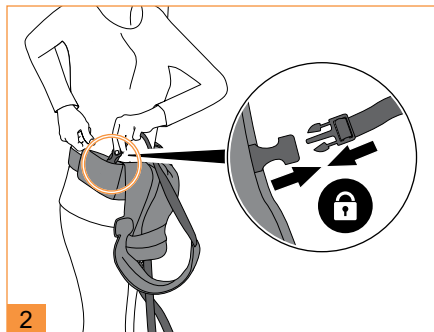
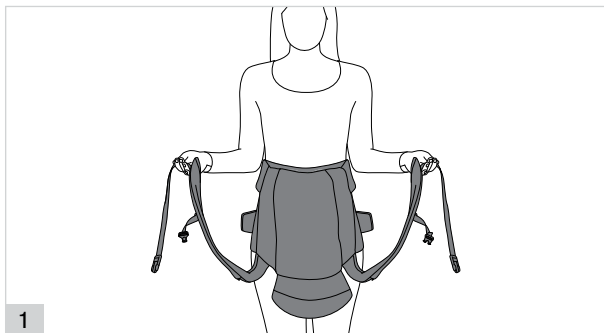

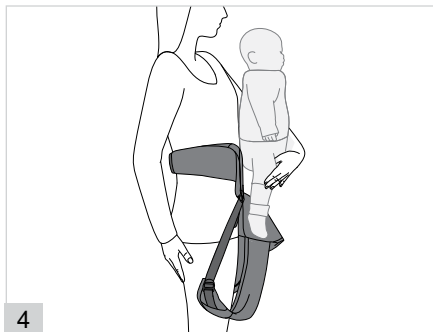
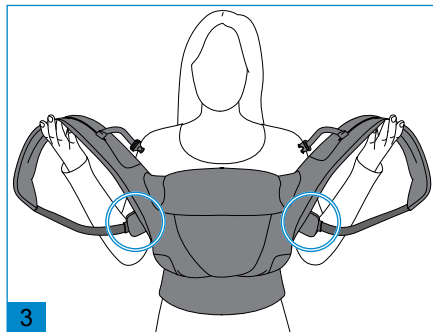
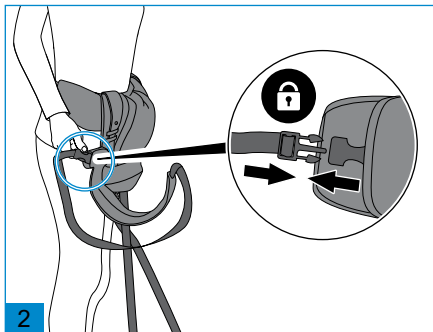

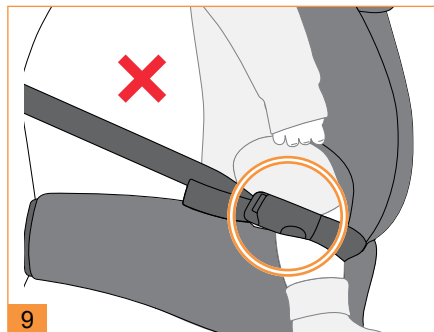
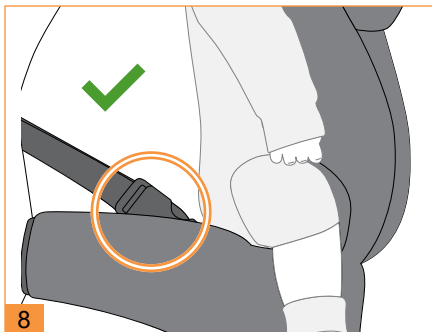
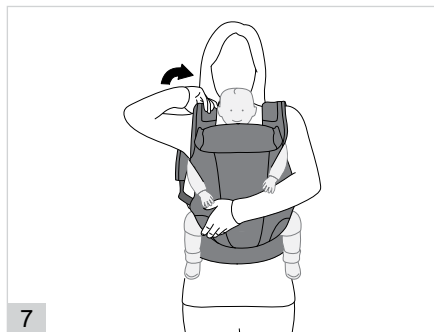

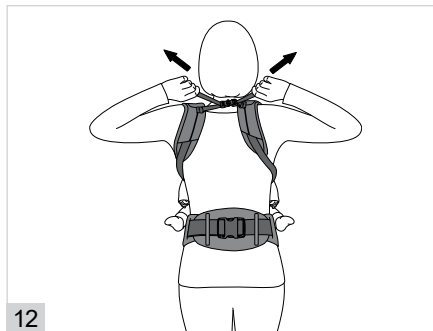
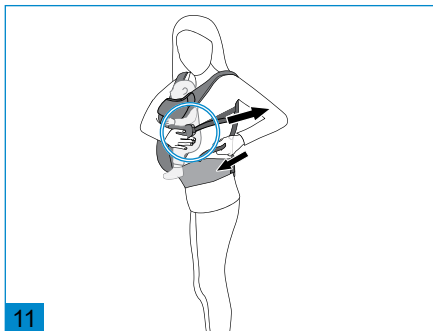
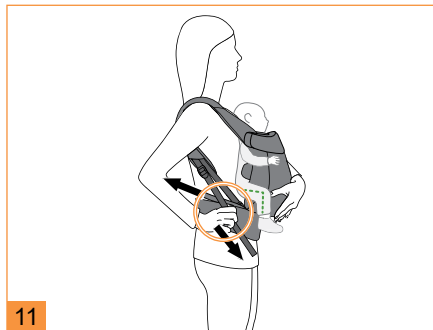
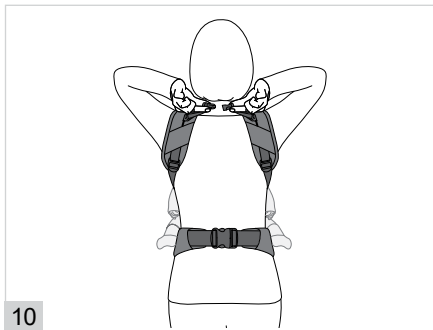

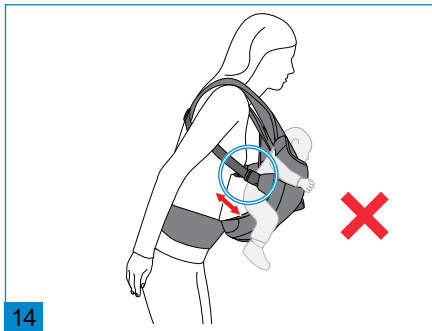
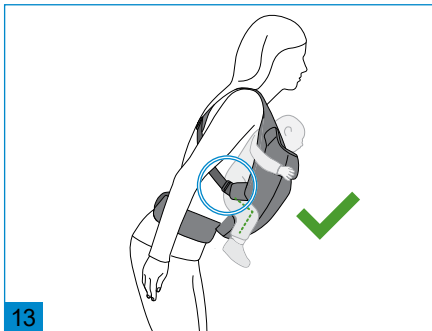
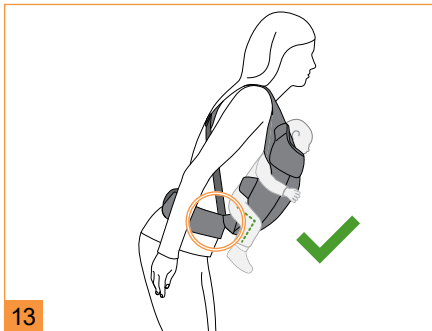

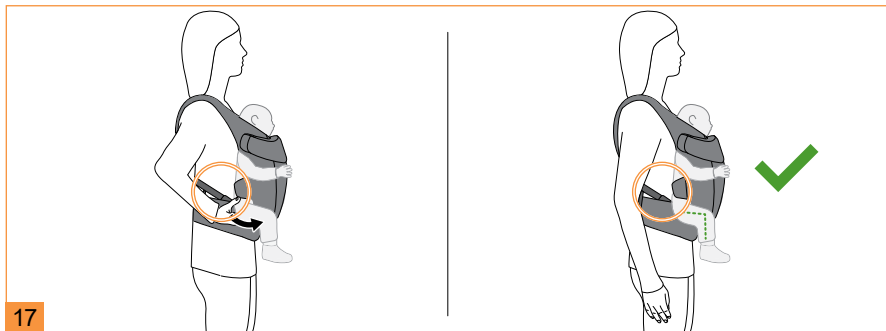
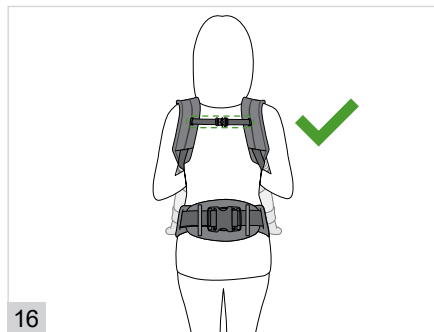

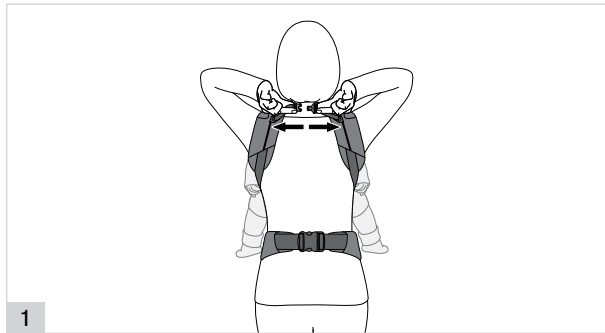

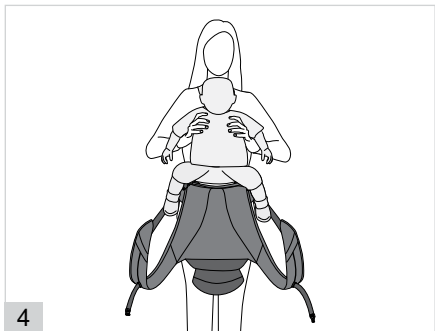

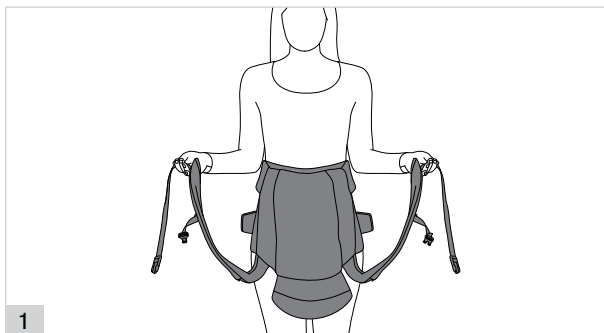

1

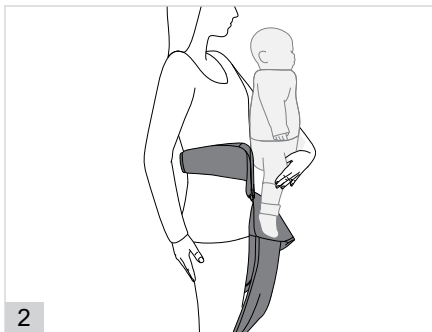

2



3

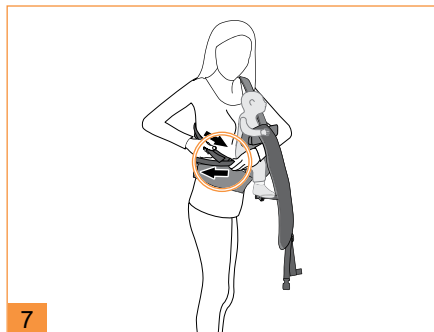
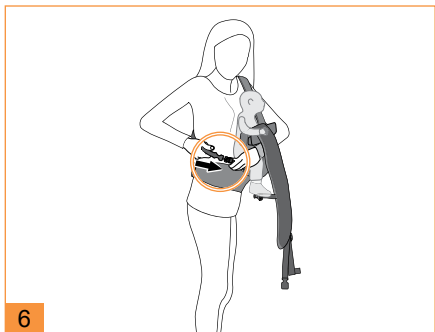
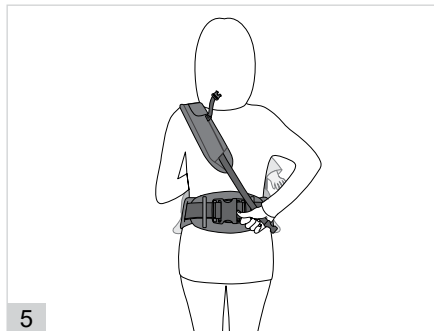

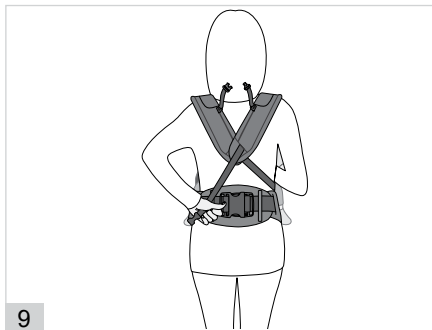
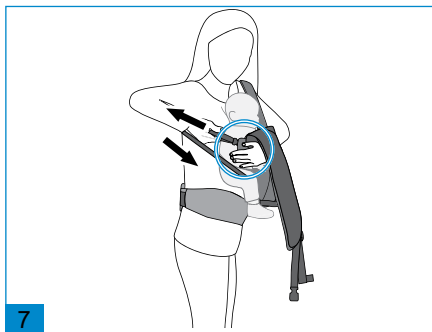
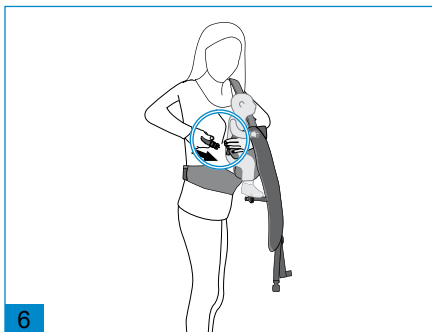

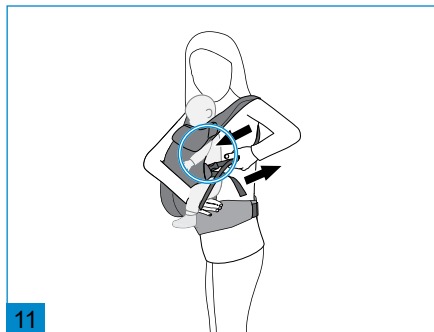
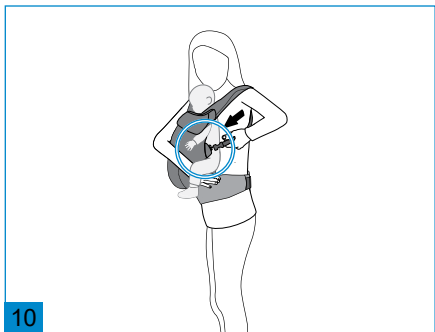

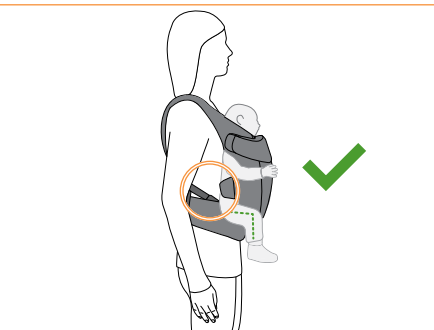
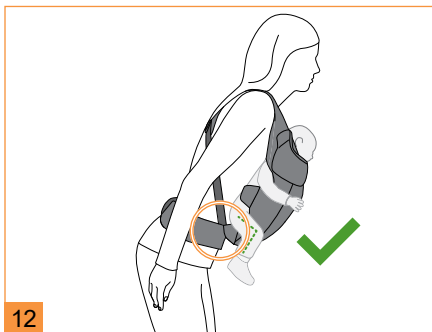

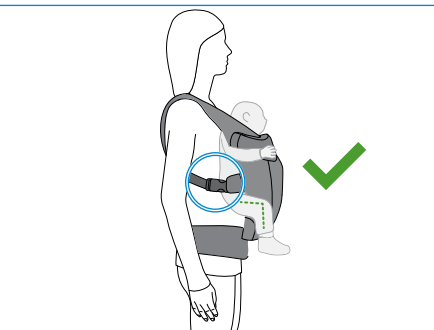
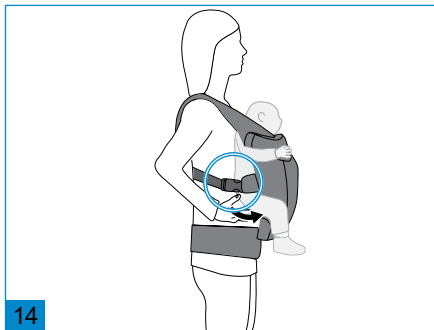
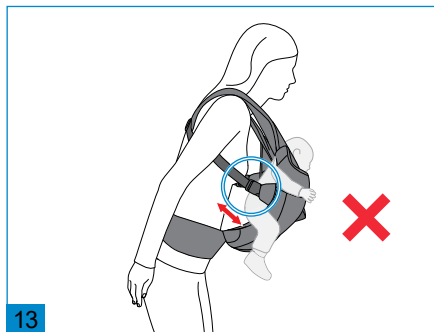
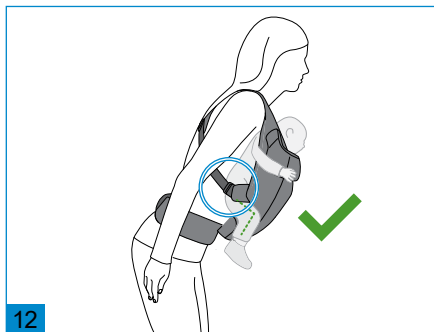

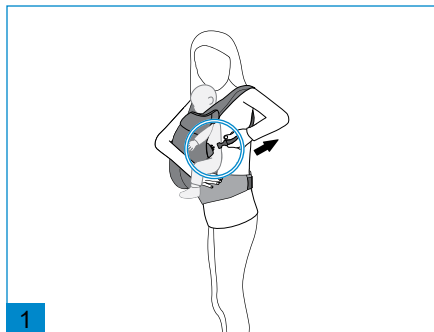

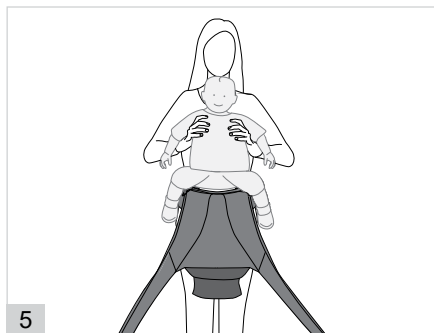
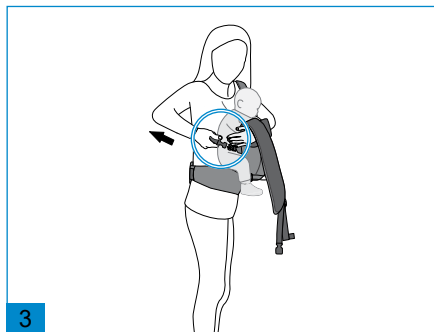
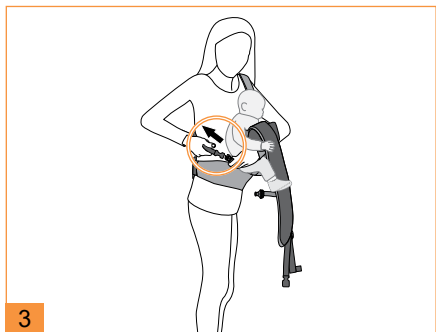

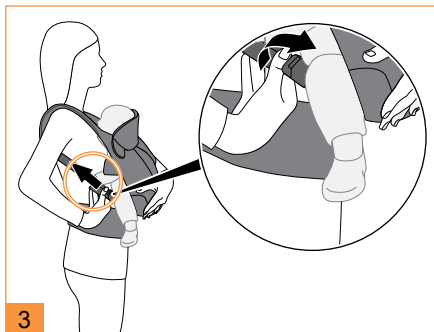
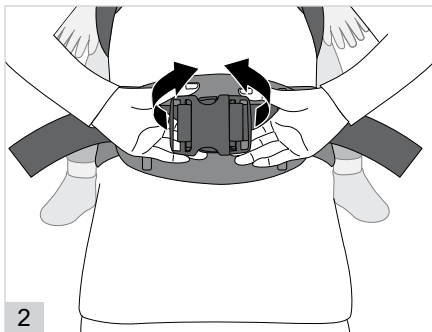

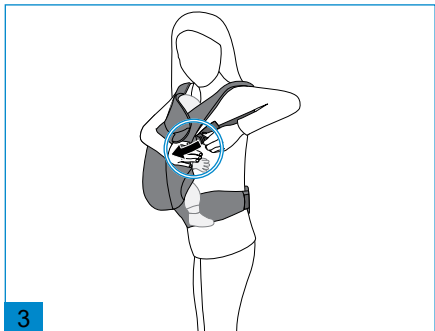

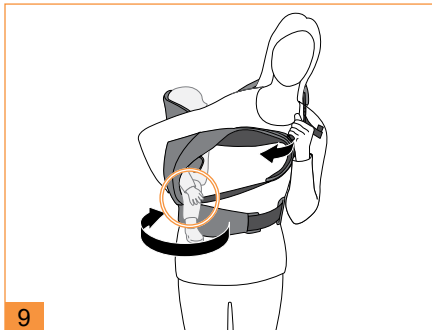
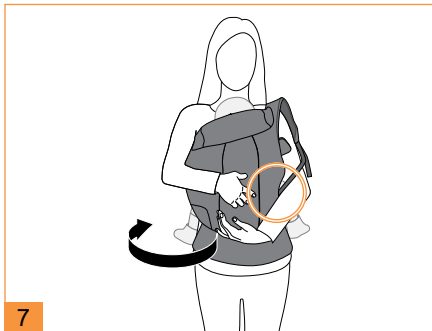

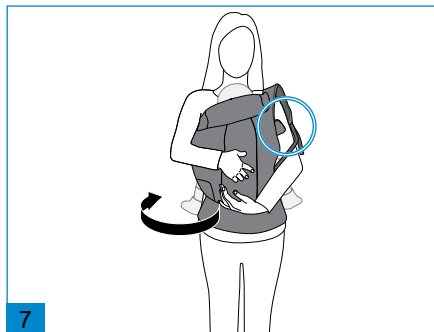
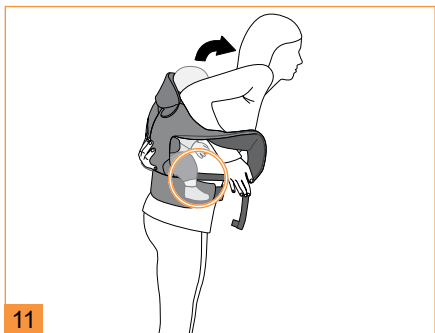

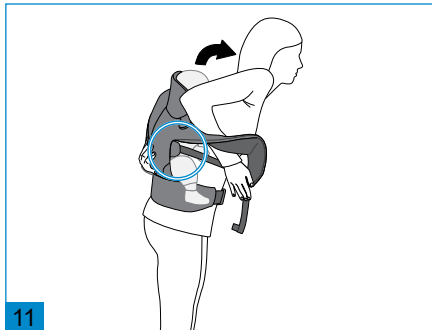
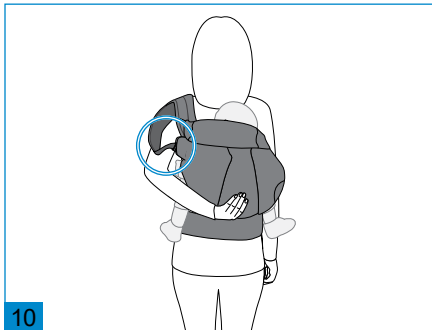
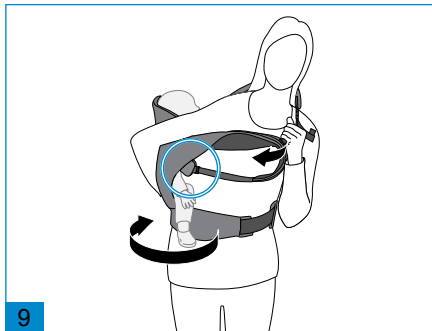
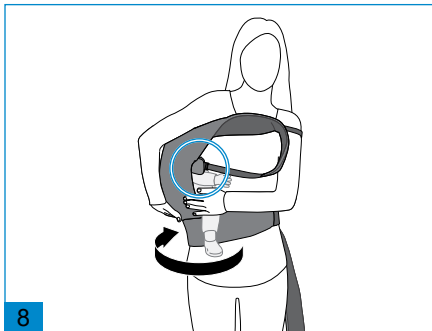

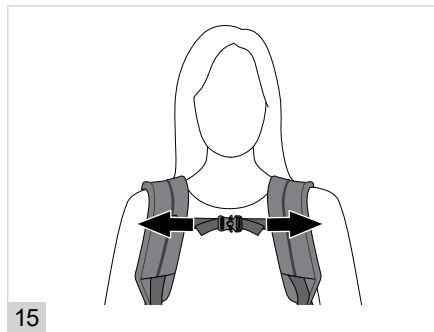
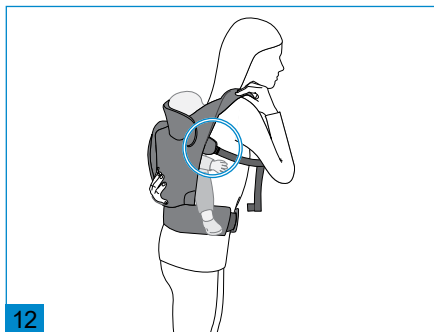

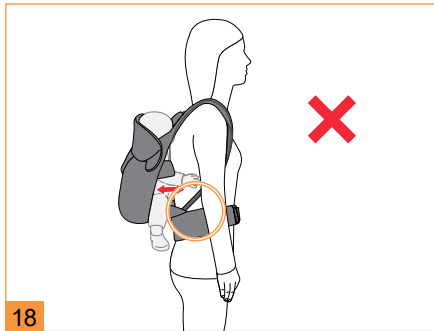
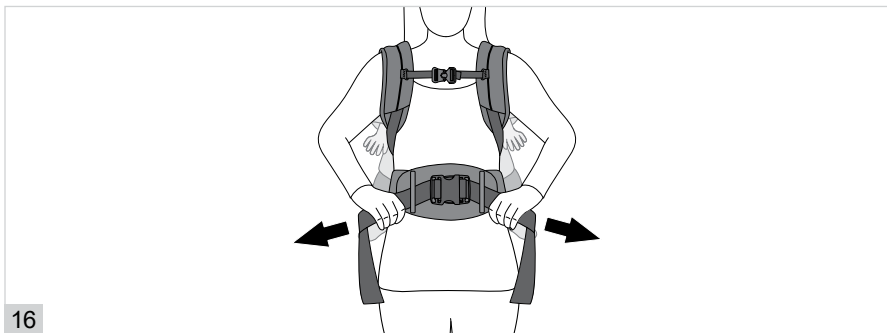

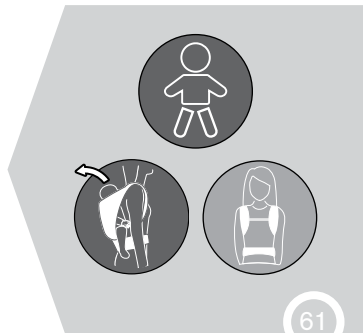
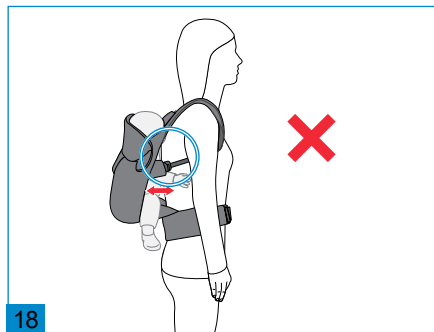
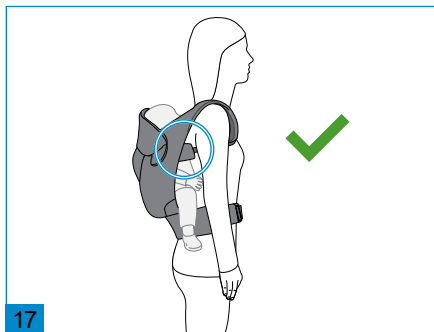

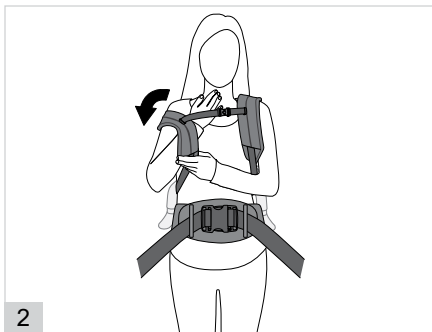
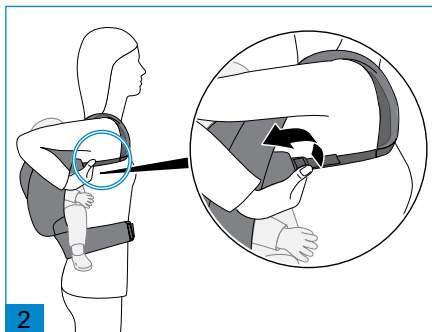
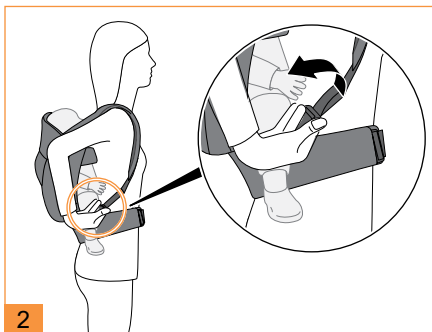

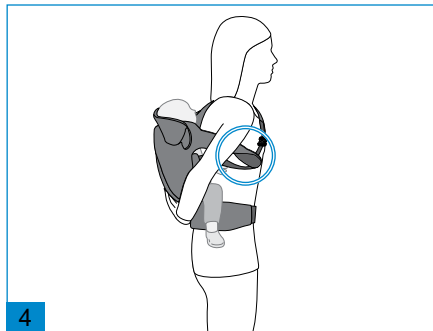
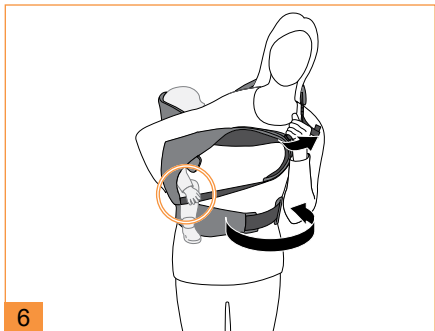

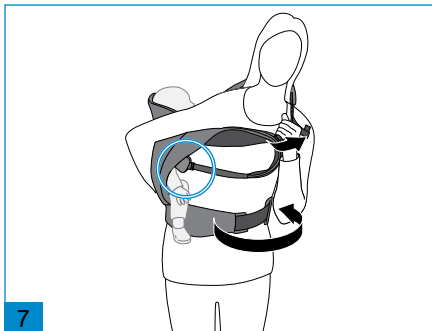
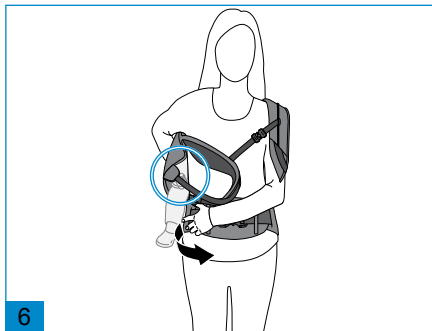
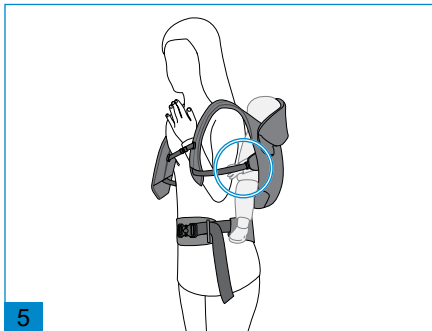

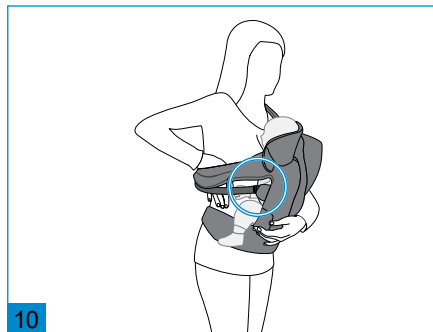
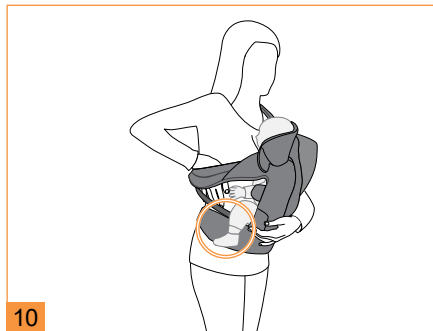

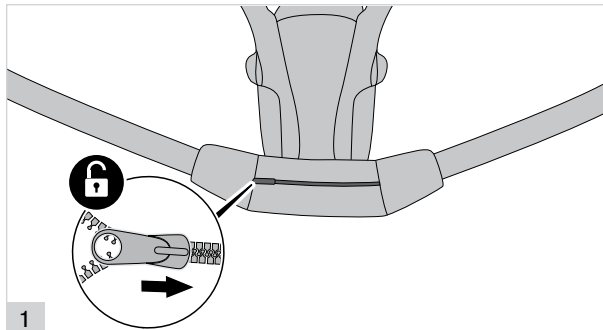
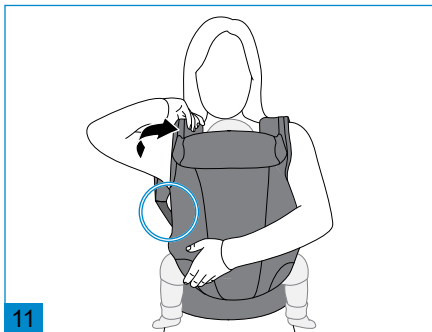

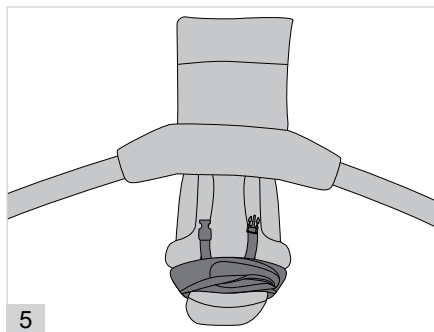
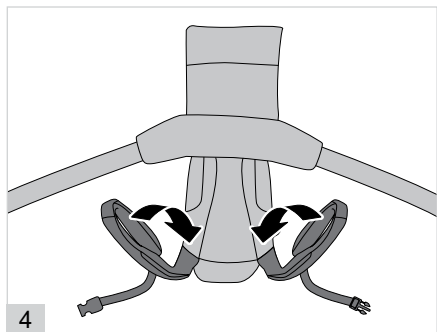
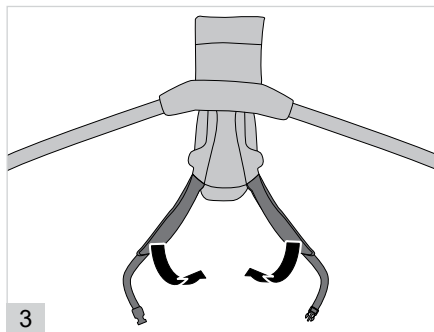
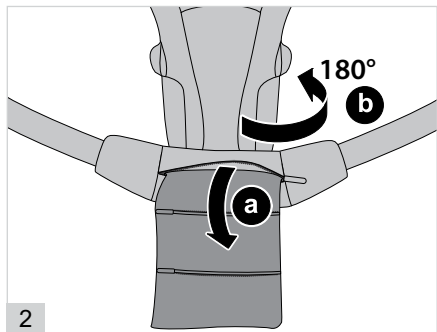

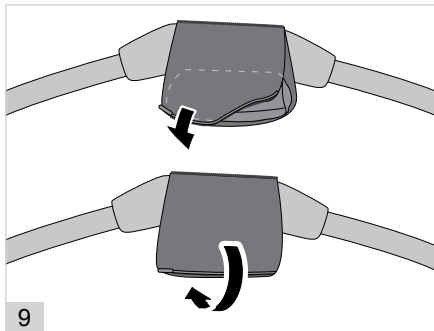
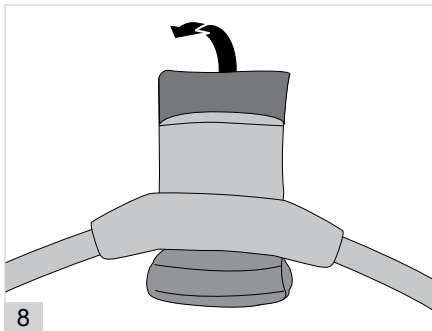
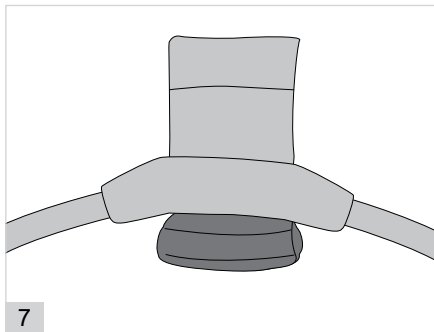
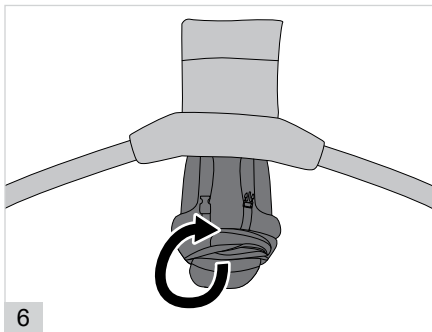

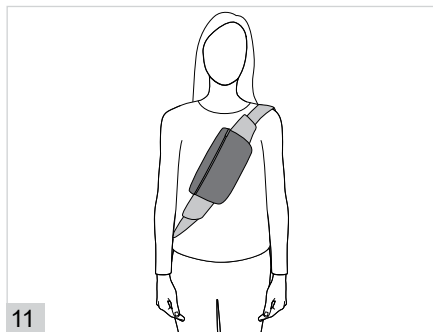
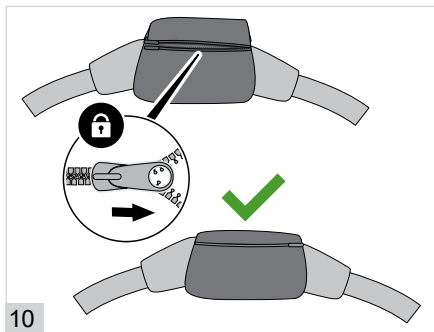







#### EUROPE AND ASIA

CYBEX GmbH  
Riedingerstraße 18  
95448 Bayreuth, Germany  
+49 (0) 921-78 511 - 0  
info@cybex-online.com

#### AMERICAS

Columbus Trading-Partners  
USA Inc.  
12915 Whitehall Park Drive,  
Suite 300, Charlotte,  
NC 28273, USA  
Customer Service:  
1-877-242-5676  
info.us@cybex-online.com

#### CANADA

Goodbaby Canada Inc.  
2 Robert Speck Parkway,  
Suite 750  
Mississauga, ON L4Z 1H8,  
Canada  
Customer Service:  
1-877-242-5676  
info.us@cybex-online.com

#### AUSTRALIA

Anstel Brands Pty Ltd  
Sunline Drive 36  
3029 Truganina, Victoria,  
Australia  
Phone: 03 9131 6545  
support@anstel.com.au

#### NEW ZEALAND

Anstel Brands Pty Ltd  
Sunline Drive 36  
3029 Truganina, Victoria,  
Australia  
Phone: 09 886 0028  
support@anstel.com.nz

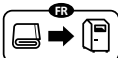

quefairedemesdechets.fr